

سیدار
SEDAR

Since 1892

YOUR
SPACE.
YOUR
ART.

SEDAR BROCHURE

Manual Roller Blind
RB 16-11 System 40®

www.sedarglobal.com

Table of Contents

System Introduction	3
System Description	4
Basic Technical Information	5
Use Cases	6
Features and Benefits	11
Options	13
Showcase	15
Other Relevant Documents	16
Contact Information	17
About Sedar	18
Highlights of our Completed Projects	19

System Introduction

Explore the **RB 16-11 Roller Blind Manual System 40®** through this brochure filled with images that showcase the system's features and demonstrates its adaptability across multiple environments. This brochure serves as a fantastic resource for picturing the transformative impact of the system on various spaces, emphasizing its design flexibility.

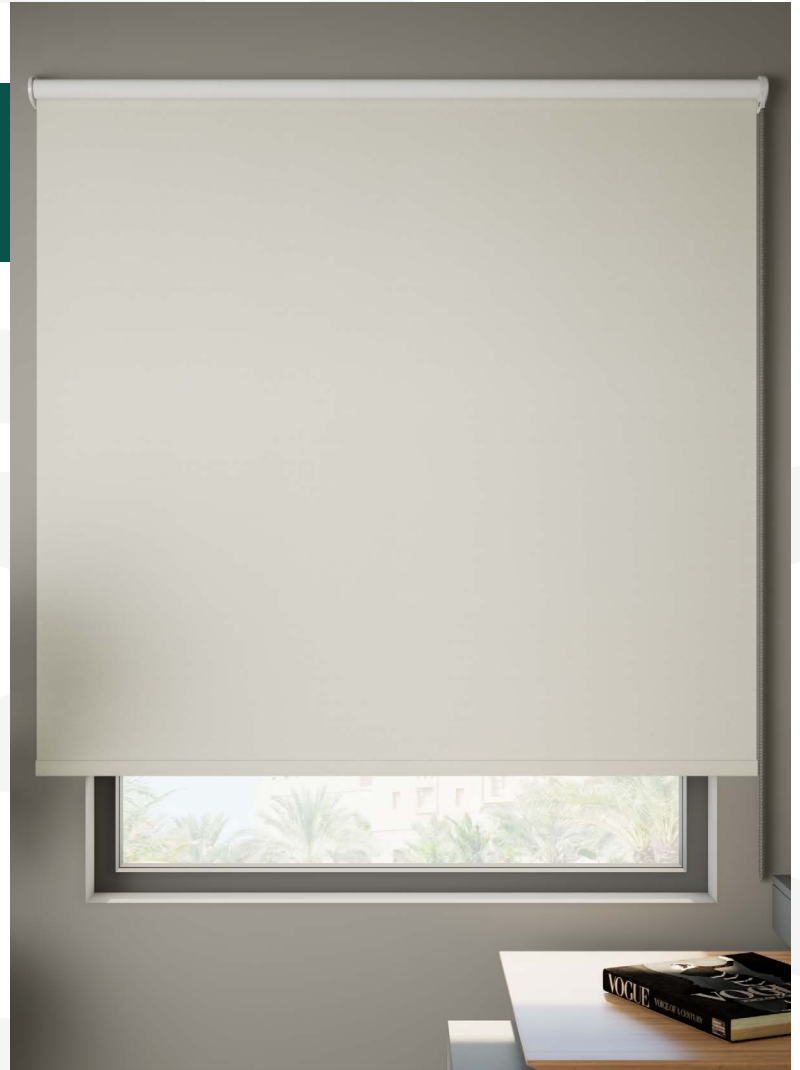

Alongside the brochure, we provide additional documents designed to meet the specific needs of professionals. These important resources can be accessed by following the links provided or scanning the QR codes below:

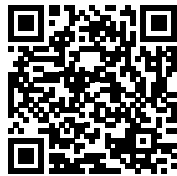

[16-11 Documents](#)

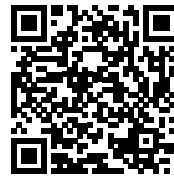

[Roller Blinds Fabric
Specifications](#)

System Description

It's time to **elevate spaces** and give them a **sophisticated upgrade** with Sedar **RB 16-11 Roller Blind Manual System 40®**, which features a durable **40 mm pipe** that is perfect for any setting from homes to large commercial venues.

This system has a **vast selection of fabric choices**, tailored to enhance both the look and functionality of the interiors.



It is a reliable, versatile choice with superior **design flexibility** and **easy installation** across various surfaces offering **custom-printed** blinds for a personal touch.

It comes with **generous warranties**, offering different coverage for different fabric types and 10-year for the system.



Basic Technical Information

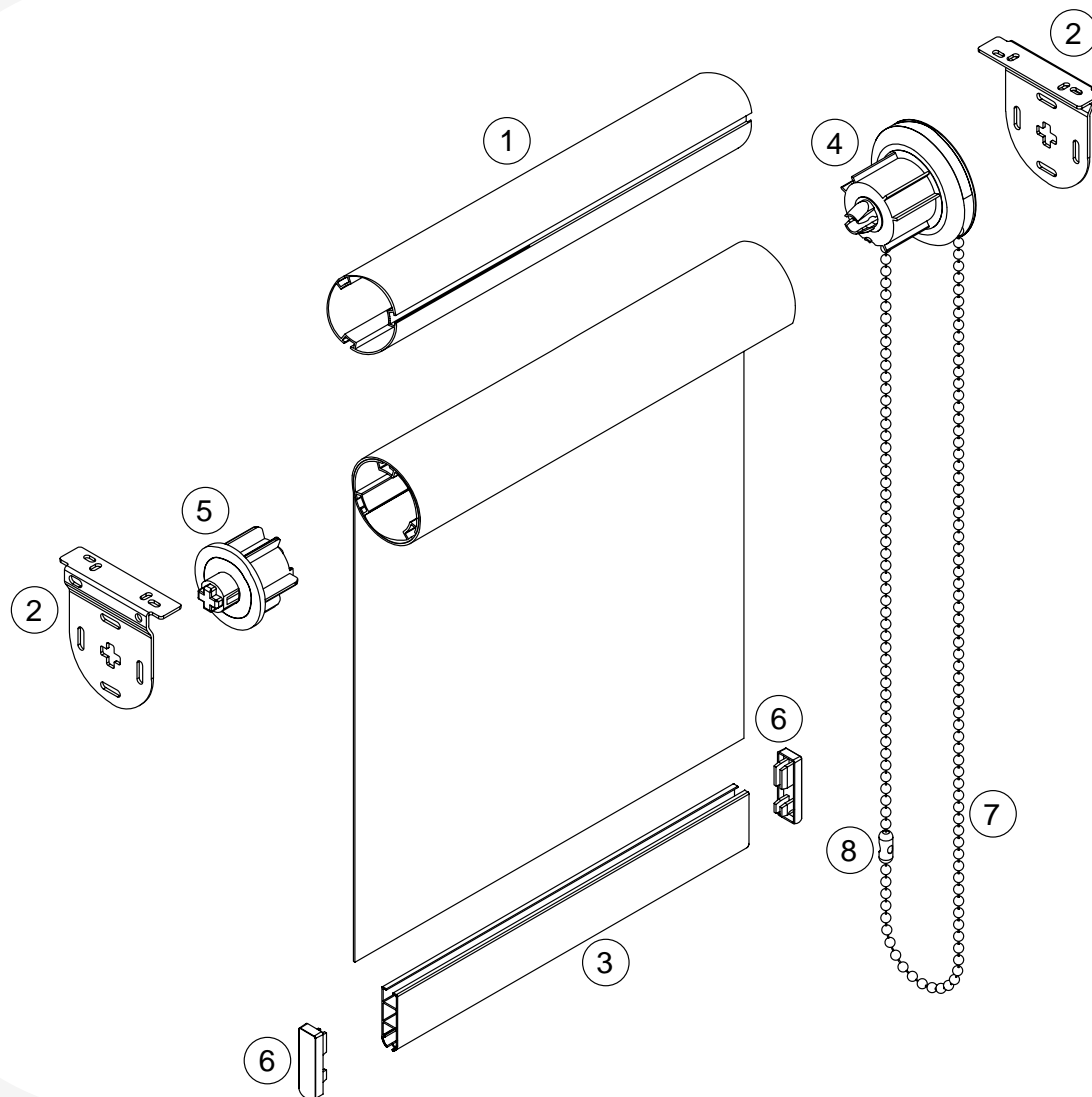

PARTS	DESCRIPTION
1	Roller Blinds Top Tube - Aluminum
2	Bracket for RB 16-11 System - White
3	Powder Coated Bottom Rail - White
4 & 5	RB 16-11 System Clutch and End Plug Set - White
6	Bottom Rail End Cap - White
7	Metal Ball Chain 4.5 mm
8	Metal Ball Connector

System

Roller Blind 40 mm (16-11)

Operation

Manual Operation with Chain

Useful Information

Optional Side Channel,
Optional Valance



Use Cases

The **RB 16-11 Manual Roller Blind System 40®** presents a versatile and innovative solution, designed to meet the dynamic needs of modern interior designers and architects.

Among its many potential applications, this system is perfectly suited for:

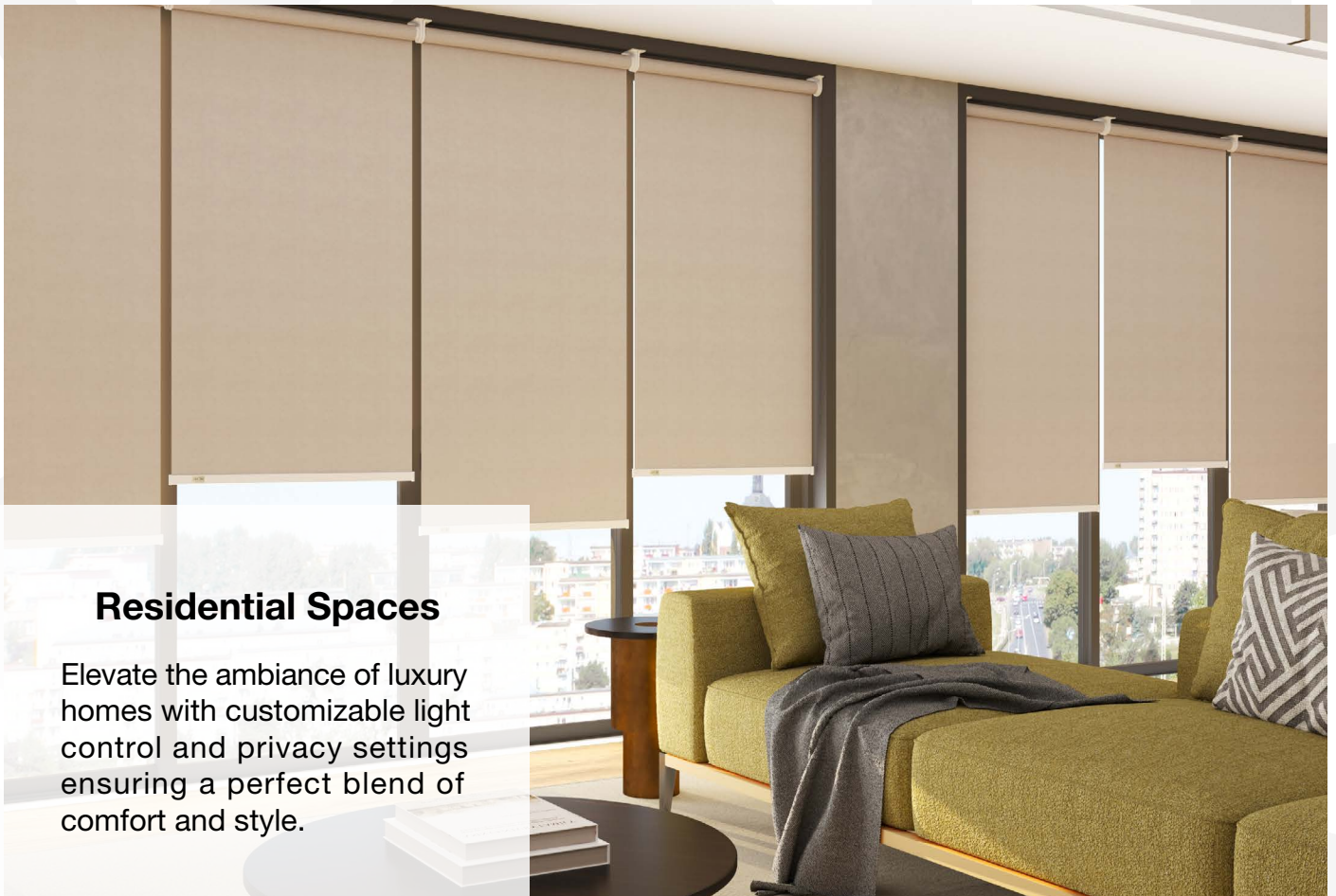

Residential Spaces

Elevate the ambiance of luxury homes with customizable light control and privacy settings ensuring a perfect blend of comfort and style.



Commercial Offices

Ideal for office environments where managing natural light and reducing glare is essential for creating productive work-spaces.

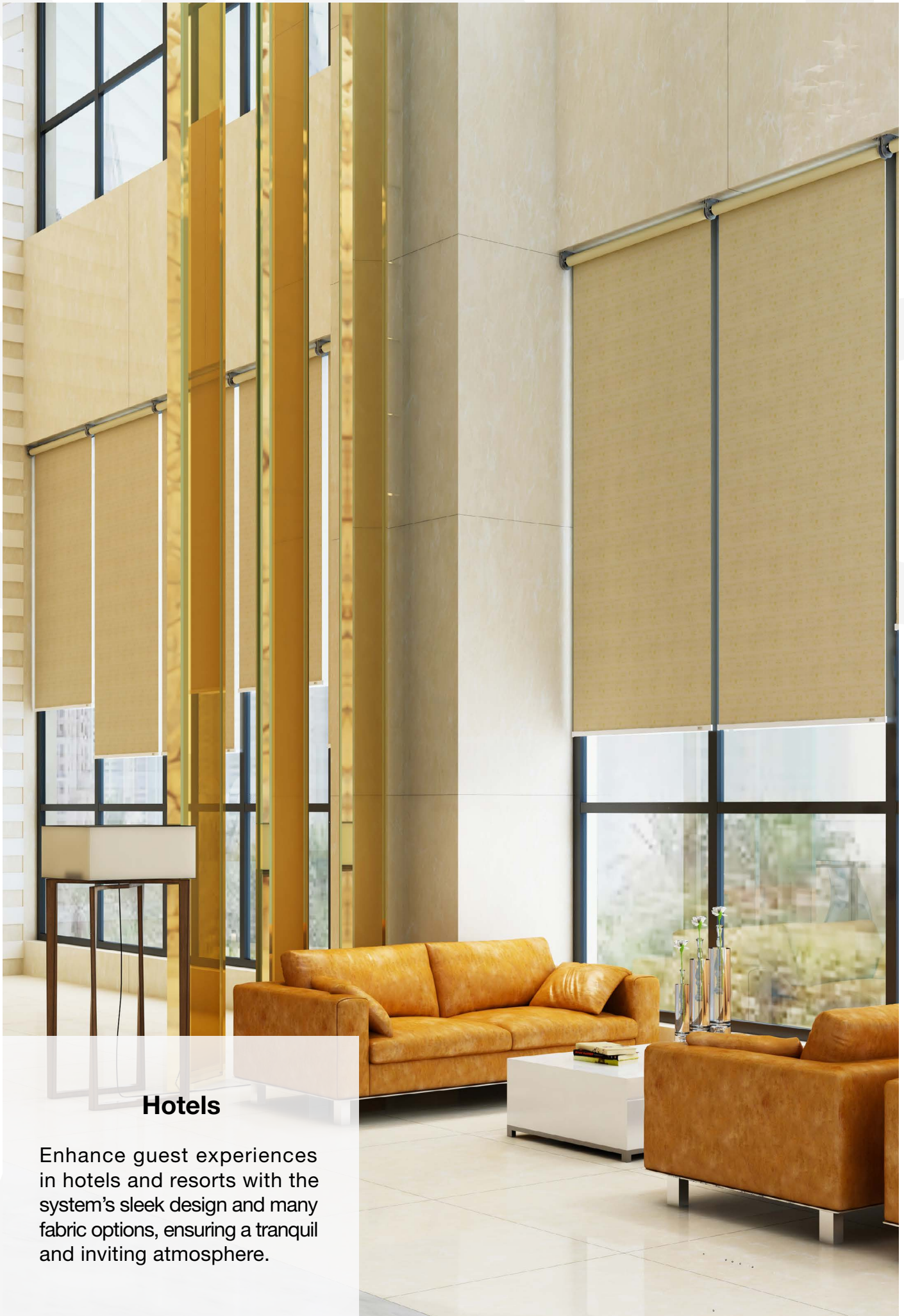

Hotels

Enhance guest experiences in hotels and resorts with the system's sleek design and many fabric options, ensuring a tranquil and inviting atmosphere.

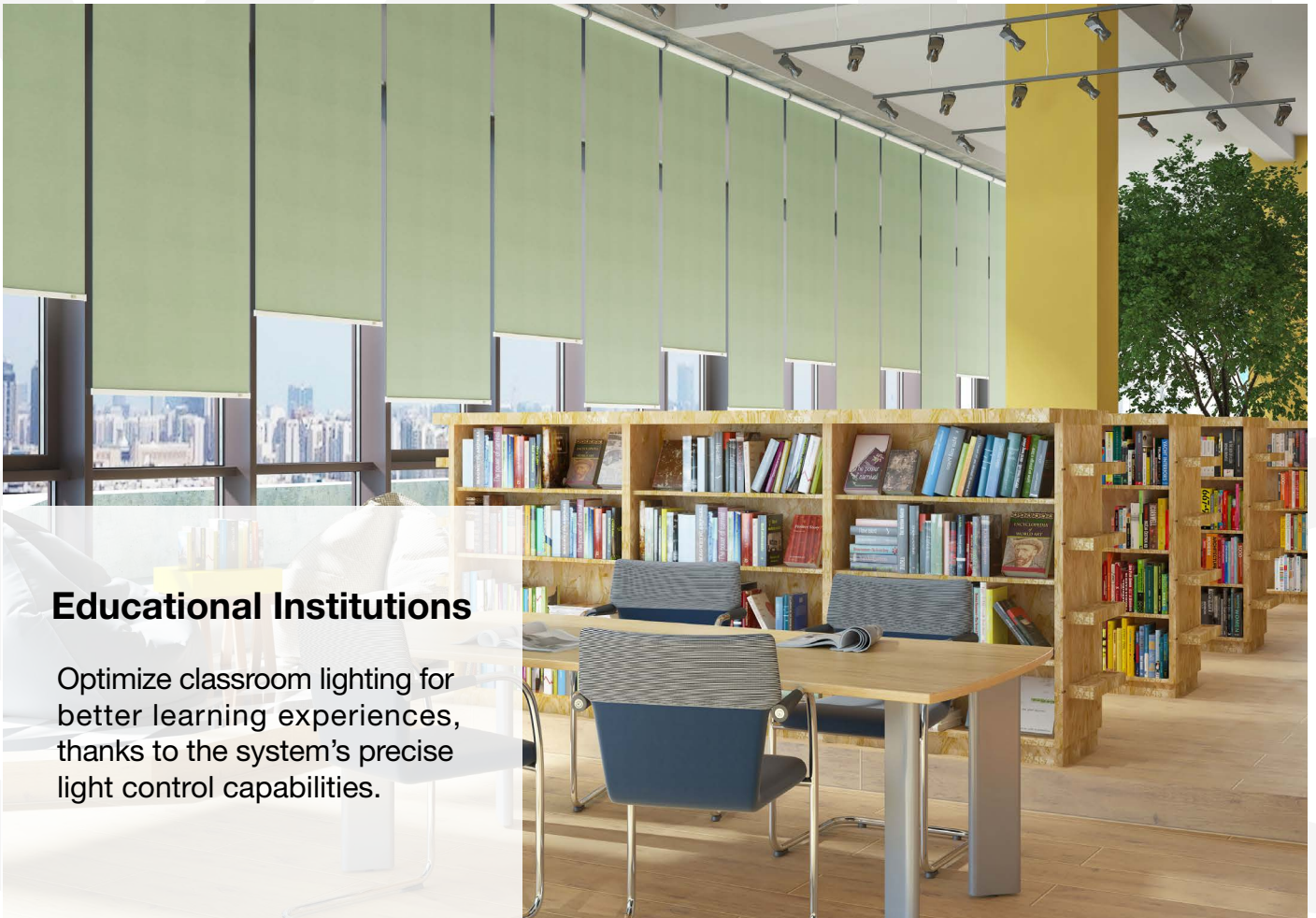

Educational Institutions

Optimize classroom lighting for better learning experiences, thanks to the system's precise light control capabilities.

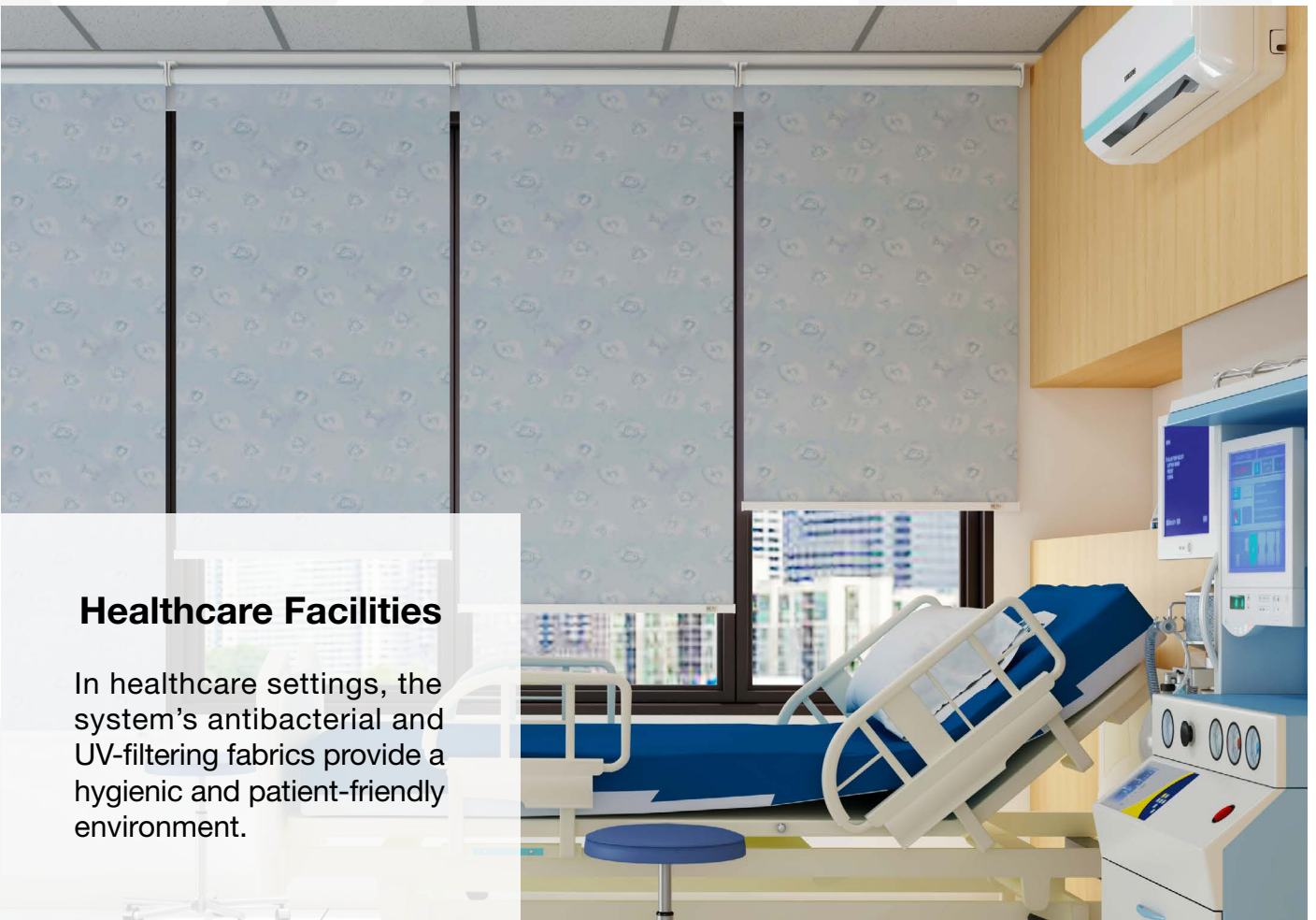

Healthcare Facilities

In healthcare settings, the system's antibacterial and UV-filtering fabrics provide a hygienic and patient-friendly environment.



Commercial Retail and Showrooms

Showcase merchandise in the best light while protecting it from UV damage, a key consideration for high-value items.

The **RB 16-11 Roller Blind Manual System 40®** is not just a window treatment; it's a design statement that speaks to functionality, aesthetic elegance, and environmental consciousness. It's a vital tool for professionals aiming to create spaces that are not only visually stunning but also comfortable and practical for their users.

Features & Benefits

Mechanical Characteristics

- Bi-directional wrap spring clutch ensures smooth operation.
- Closed system design keeps internal components protected and maintenance-free.
- Narrow edge light gap to reduce light entry.
- Fabric area capable of covering up to system capacity of 6.5 m².
- Roller dual bracket for back to back blind installation.
- Compatible with a variety of surfaces for installation, including concrete, wood, reinforced gypsum, and metal.



Fabric Qualities

- **Fire Retardant:** Our fabrics include options for enhanced safety through fire retardancy.
- **Light Transparency & UV Protection:** Offering a range from regular to blackout, catering to various lighting needs.
- **Sustainable Materials:** Committed to environmental responsibility, our materials are recyclable and eco-friendly.



Aesthetic Elements

- The system offers personalized printing for tailored designs, ensuring a sleek, modern look that seamlessly integrates with any interior decor.
- Consistency in design is maintained across various applications to enhance the overall aesthetic appeal.

Warranty and Assurance

- Different coverage for different fabric types.
- 10 year warranty for this system.



Each feature of **RB 16-11 Roller Blind Manual System 40®** not only meets but exceeds expectations in functionality, safety and style.

Options



Discover the unparalleled elegance and functionality of the **RB 16-11 Roller Blind Manual System 40[®]** with Side Channel option, meticulously crafted for the modern space.

Side Channel Options

Side channels help eliminate gaps to block out light and increase privacy, while also stabilizing the blinds to prevent swaying. These channels are mounted along the window frame for a seamless and aesthetic intergration.

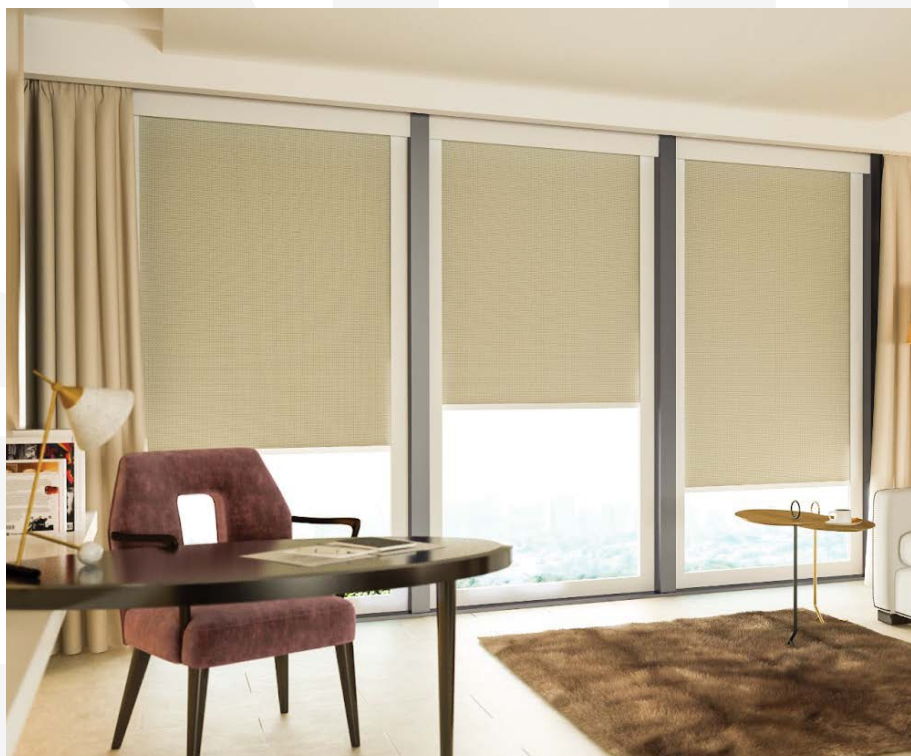



Moreover, it enhances the visual flow from wall to window and boosts insulation, reducing energy loss. A valance is an essential upgrade, marrying elegance with efficiency for your window treatments.

Valance Options

Add a touch of sophistication and practicality to your roller blinds with a sleek valance. This stylish addition conceals hardware, minimizes dust accumulation, and protects the mechanism, thereby extending the system's lifespan with less maintenance.



The dual bracket option in this system allows for the efficient installation of two blinds in a back to back arrangement, simplifying the process and saving time. This feature is particularly useful in spaces where varying light control is needed, as it enables the mounting of both blackout and see-through blinds together.

Dual Bracket Options



The streamlined design ensures a neat and cohesive look, making it an ideal solution for both functional and aesthetic needs in various environments.

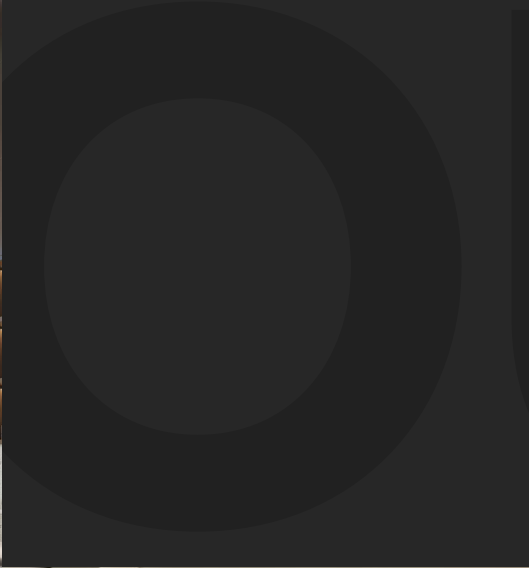

SEDARGLOBAL BROCHURE

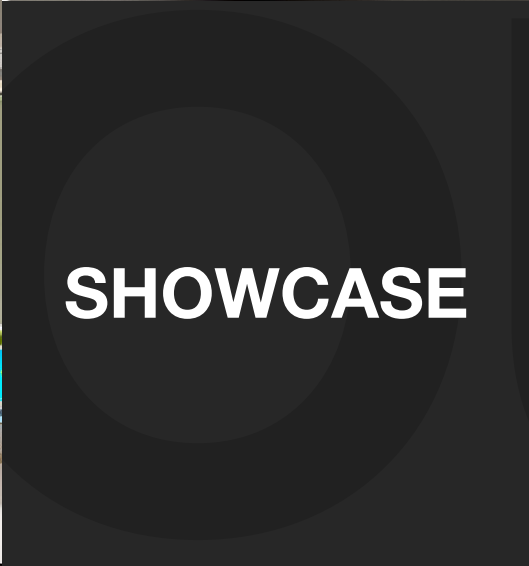

Other Relevant Documents

To further explore the **RB 16-11 Manual Roller Blind System 40®**
Please click the links below or scan the QR codes.

These will direct you to additional documents designed to meet your specific needs.



[16-11 Documents](#)



[Roller Blinds Fabric Specifications](#)

Projects and Professionals

Contact Information

For inquiries about the **RB 16-11 Roller Blind Manual System 40®** or to utilize our Projects Department's bespoke services, please contact us. Our team is ready to assist with product details, installation, and custom solutions, ensuring your design needs are expertly met. Contact us using the QR code below for guidance in transforming your spaces with innovation and style.



Email: projects@sedarglobal.com

Contact or call our hotline on

WhatsApp: [+971502313453](https://wa.me/971502313453)



About Sedar

Sedar Global is a leading home decor business around the MENA region. We provide a wide range of window treatment & wallpaper solutions, as well as folding doors, soft furnishing, smart solutions, outdoor solutions & more.

We are a fourth generation family business with our roots going back to 1892. Our long lasting ethics and principles have enriched the Sedar business with deep family values.

We operate as a single, international, trust-worthy brand with a culture oriented on exceeding every customer expectation. We have 3 factories, and over 30+ outlets in UAE, Saudi Arabia, Qatar, Oman and Bahrain.

Highlights of our Completed Projects

Here are some highlights of our completed projects, illustrating our extensive reach and expertise. These projects showcase our ability to deliver quality and excellence across various sectors, including aviation, hospitality, healthcare, corporate, residential, and industrial.



Abu Dhabi Investment Authority - Abu Dhabi

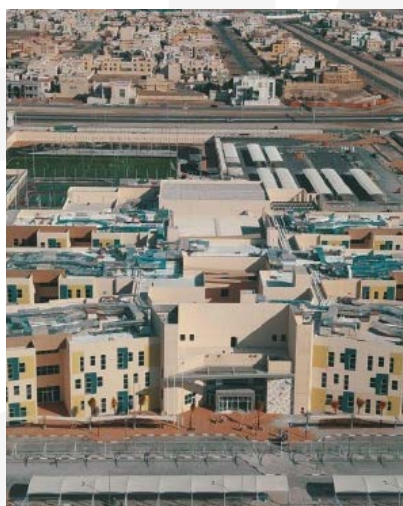

300+ Government Schools, Musanada - Abu Dhabi



Islamic Bank - Sharjah



Paramount Towers Damac - Dubai



Burj Al Arab - Dubai



Etisalat Tower - Dubai



Emirates Airlines Headquarters - Dubai



Dr. Sulaiman Al Habib Hospital - Dubai



One Za'abeel Ithra - Dubai



Jumeirah Beach Hotel - Dubai



Kempinski Residences - Dubai



Nakheel Island - Dubai



Raffles The Palm Resort - Dubai



Almoosa Specialist Hospital, Ehsaa - KSA



Movenpick Hotel Al Khobar - KSA



Ramada Al Khobar - KSA

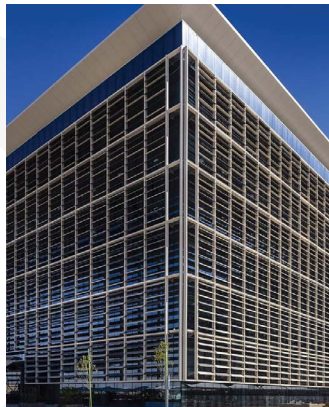

Saudi Electricity Company - KSA



Holiday Inn Al Khobar - KSA



JW Marriott Hotel - Qatar



Ministry of Justice - Riyadh



Ministry of Health - Riyadh



Hyatt Regency - Riyadh



Qatar National Bank



Swiss Hotel Doha - Qatar



Muscat Securities Market - Oman



Nissan Showroom - Oman



Oman Tel - Oman



Salalah Airport - Oman



Ghala Heights Mixed-Use development Muscat-Oman



Avani Muscat Hotel & Suites - Muscat Oman



Ministry of Foreign Affairs - Oman

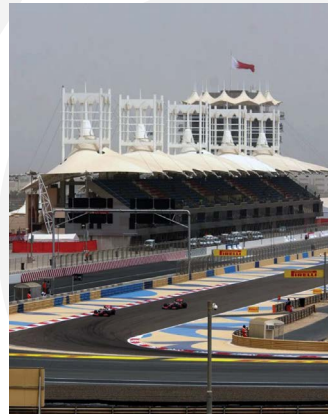

Bahrain Grand Prix



DHL - Bahrain

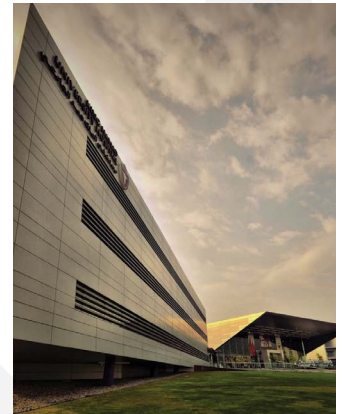

King Hamad Hospital - Bahrain



S Hotel Manama - Bahrain



Nestle Waters - Bahrain

SEDAR BROCHURE

سیدار SEDAR

— Since 1892 —