

سیدار SEDAR

Since 1892

YOUR SPACE. YOUR ART.

MANUAL RAIL SYSTEM

RB 16-64 Roller Harmony Classic®

www.sedarglobal.com

Table of Contents

System Introduction	3
System Description	4
Basic Technical Information	5
Use Cases	6
Features and Benefits	11
Showcase	
Other Relevant Documents	14
Contact Information	15
About Sedar	16
Highlights of our Completed Projects	17

System Introduction

Explore the **RB 16-64 Roller Harmony Manual Rail System-Classic®** through this brochure filled with images that showcase the system's features and demonstrates its adaptability across multiple environments.

This brochure serves as a fantastic resource for picturing the transformative impact of the system on various spaces, emphasizing its design flexibility.



Alongside the brochure, we provide additional documents designed to meet the specific needs of professionals. These important resources can be accessed by following the links provided or scanning the QR codes below:



[16-64 Documents](#)



[Roller Blinds Fabric Specifications](#)

System Description

It's time to **elevate spaces** and give them a **sophisticated upgrade** with **Sedar RB 16-64 Roller Harmony Manual Rail System - Classic®**, perfect for any settings from homes to large commercial venues.

It features a durable **35 mm pipe** with a **harmony classic cassette** that shields the mechanism from dust and damage, **reducing maintenance**, and **extending system life**.



This system has a **vast selection of fabric choices** tailored to enhance both the look and functionality of the interiors.

It comes with **generous warranties**, offering 1-year of coverage for the fabric and 1-year for the mechanical parts.

It is a reliable, versatile choice with superior **design flexibility** and **easy installation** across various surfaces.



Basic Technical Information

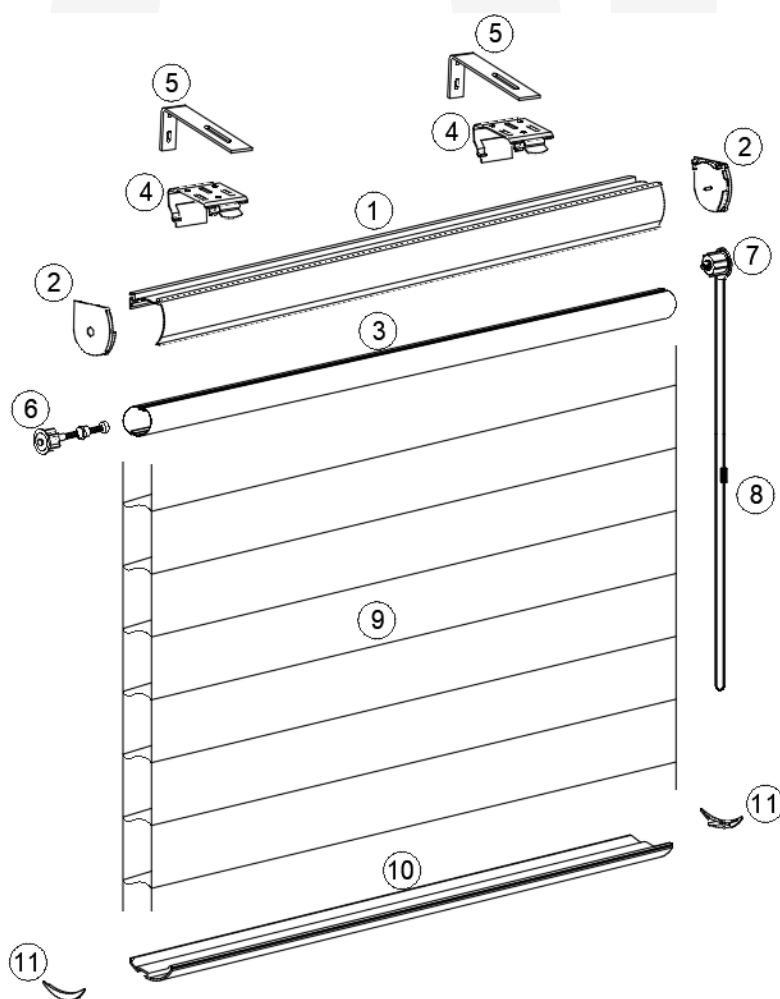

PARTS	DESCRIPTION
1	Harmony Classic Cassette
2	Harmony Head Rail End cap
3	Roller Blinds Top Tube - Aluminum
4	Bracket for RB 16-64
5	L clip brackets
6 & 7	RB 16-64 System Clutch and End Plug Set
8	Control Cord 3.2mm
9	Harmony Fabrics
10	Powder Coated Bottom Rail
11	Bottom Rail End Cap

System

Roller Blind Harmony System
Classic (16-64)

Operation

Manual Operation With
Chain

Useful Information

Valance - Harmony Classic
Cassette



Use Cases

The **RB 16-64 Roller Harmony Manual Rail System - Classic®** presents a versatile and innovative solution, designed to meet the dynamic needs of modern interior designers and architects.

Among its many potential applications, this system is perfectly suited for:

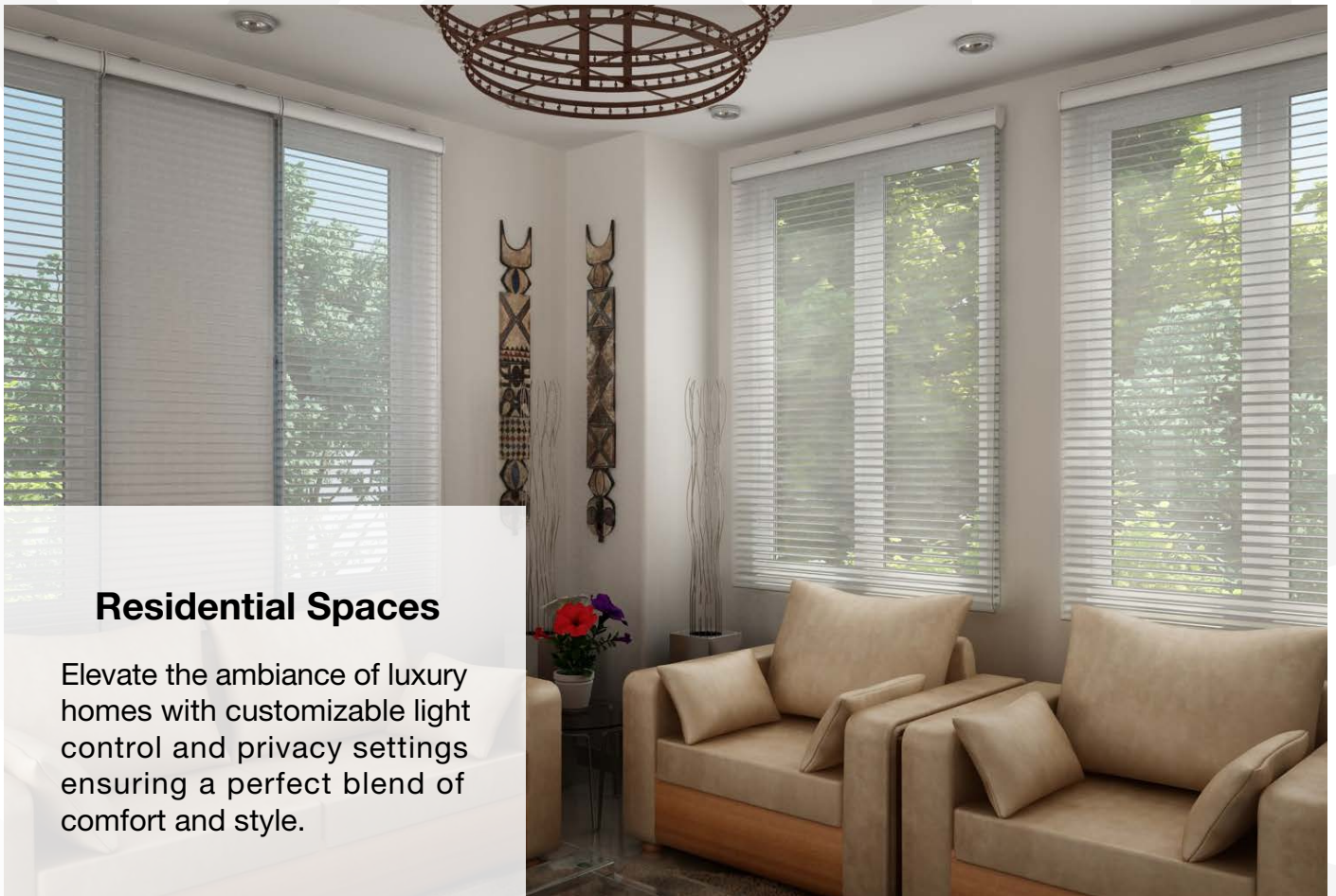

Residential Spaces

Elevate the ambiance of luxury homes with customizable light control and privacy settings ensuring a perfect blend of comfort and style.



Commercial Offices

Ideal for office environments where managing natural light and reducing glare is essential for creating productive work-spaces.

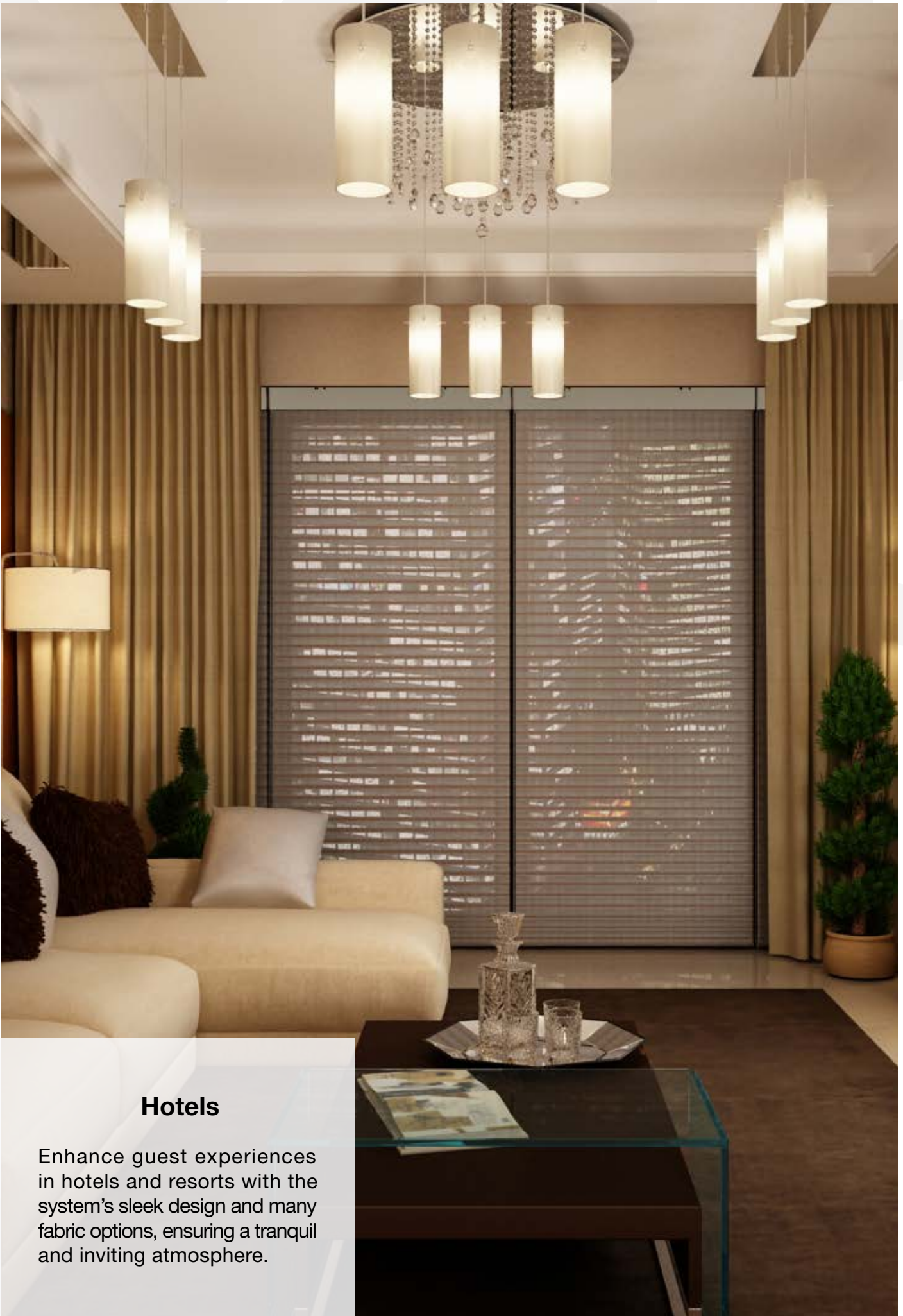

Hotels

Enhance guest experiences in hotels and resorts with the system's sleek design and many fabric options, ensuring a tranquil and inviting atmosphere.



Educational Institutions

Optimize classroom lighting for better learning experiences, thanks to the system's precise light control capabilities.

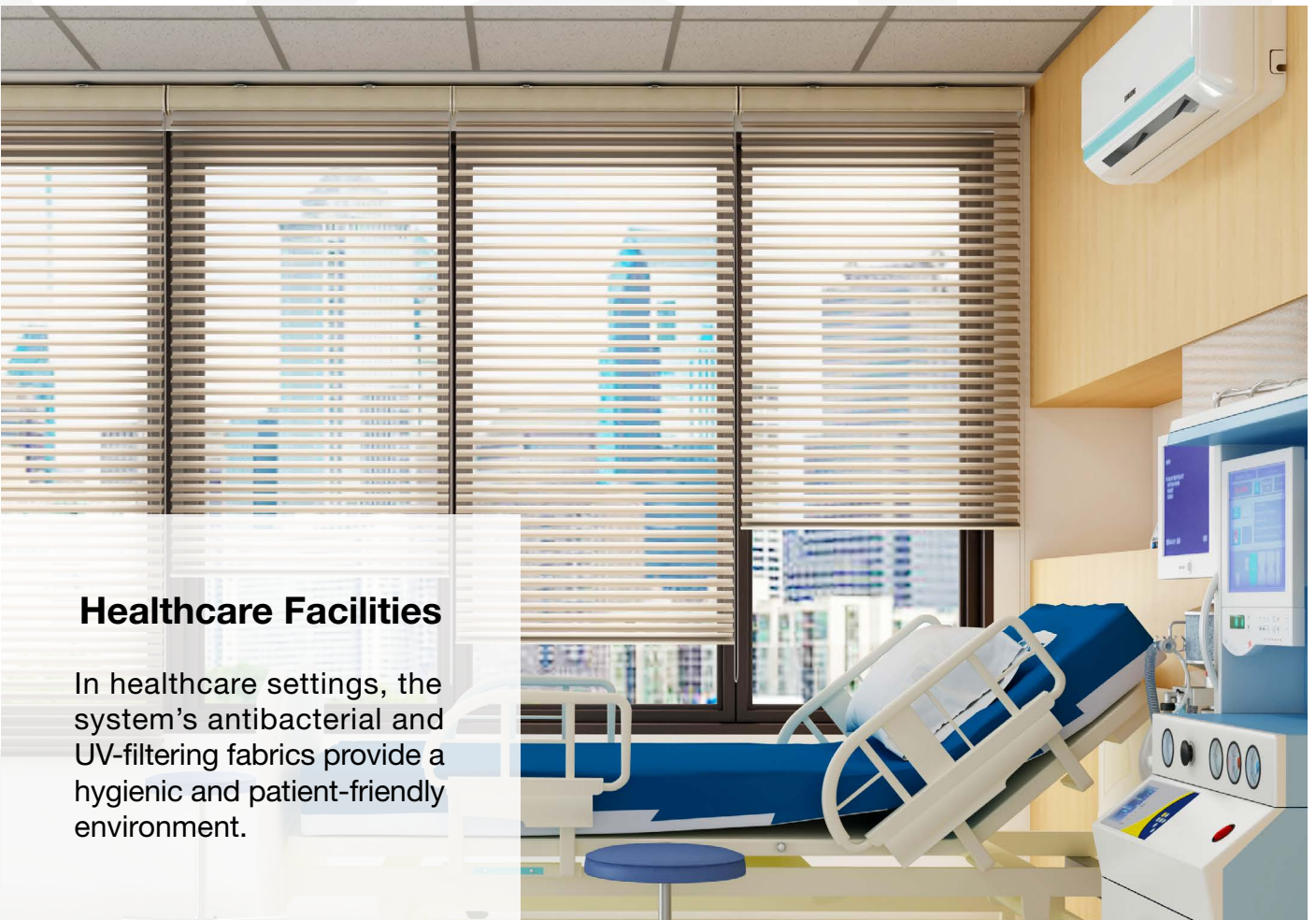

Healthcare Facilities

In healthcare settings, the system's antibacterial and UV-filtering fabrics provide a hygienic and patient-friendly environment.



Commercial Retail and Showrooms

Showcase merchandise in the best light while protecting it from UV damage, a key consideration for high-value items.

The **RB 16-64 Roller Harmony Manual Rail System - Classic®** is not just a window treatment; it's a design statement that speaks to functionality, aesthetic elegance, and environmental consciousness. It's a vital tool for professionals aiming to create spaces that are not only visually stunning but also comfortable and practical for their users.

Features & Benefits

Mechanical Characteristics

- Bi-directional wrap spring clutch ensures smooth operation.
- Closed system design keeps internal components protected and maintenance free.
- Narrow edge light gap to reduce light entry.
- Fabric area capable of covering up to its system capacity of **6.5 m²**.
- Compatible with a variety of surfaces for installation, including concrete, wood, reinforced gypsum, and metal.
- Harmony classic cassette that shields the mechanism from dust and damage, reducing maintenance, and extending system life.



Fabric Qualities

- **Fire Retardant:** Our fabrics include options for enhanced safety through fire retardancy.
- **Light Transparency & UV Protection:** Offering a range from regular to blackout, catering to various lighting needs.
- **Sustainable Materials:** Committed to environmental responsibility, our materials are recyclable and eco-friendly.



Aesthetic Elements

- Consistency in design is maintained across various applications to enhance the overall aesthetic appeal.

Warranty and Assurance

- 1-year warranty on fabric, ensuring long-term quality and satisfaction.
- 1-year warranty on mechanical parts, guaranteeing durable performance.



Each feature of **RB 16-64 Roller Harmony Manual Rail System - Classic®** not only meets but exceeds expectations in functionality, safety and style.



SEDAR BROCHURE

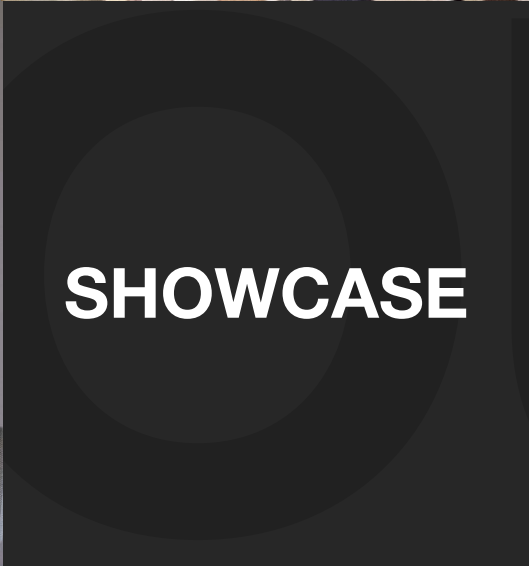

Other Relevant Documents

To further explore the **RB 16-64 Roller Harmony Manual Rail System - Classic®** Please click the links below or scan the QR codes.

These will direct you to additional documents designed to meet your specific needs.



[16-64 Documents](#)



[Roller Blinds Fabric Specifications](#)

Projects and Professionals

Contact Information

For inquiries about the **RB 16-64 Roller Harmony Manual Rail System - Classic®** or to utilize our Projects Department's bespoke services, please contact us. Our team is ready to assist with product details, installation, and custom solutions, ensuring your design needs are expertly met. Contact us using the QR code below for guidance in transforming your spaces with innovation and style.



Email: projects@sedarglobal.com

Contact or call our hotline on

WhatsApp: [+971502313453](https://wa.me/971502313453)



About Sedar

Sedar Global is a leading home decor business around the MENA region. We provide a wide range of window treatment & wallpaper solutions, as well as folding doors, soft furnishing, smart solutions, outdoor solutions & more.

We are a fourth generation family business with our roots going back to 1892. Our long lasting ethics and principles have enriched the Sedar business with deep family values.

We operate as a single, international, trust-worthy brand with a culture oriented on exceeding every customer expectation. We have 3 factories, and over 30+ outlets in UAE, Saudi Arabia, Qatar, Oman and Bahrain.

Highlights of our Completed Projects

Here are some highlights of our completed projects, illustrating our extensive reach and expertise. These projects showcase our ability to deliver quality and excellence across various sectors, including aviation, hospitality, healthcare, corporate, residential, and industrial.



Abu Dhabi Investment Authority - Abu Dhabi

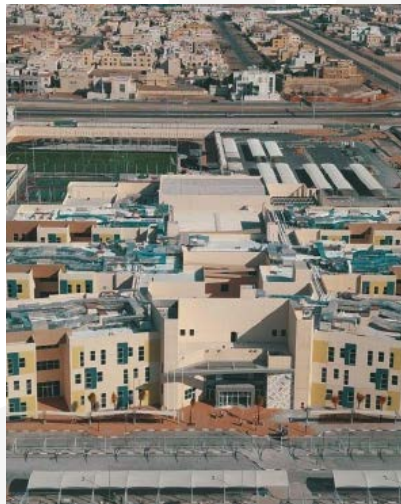

300+ Government Schools, Musanada - Abu Dhabi



Islamic Bank - Sharjah



Paramount Towers Damac - Dubai



Burj Al Arab - Dubai



Etisalat Tower - Dubai



Emirates Airlines Headquarters - Dubai



Dr. Sulaiman Al Habib Hospital - Dubai



One Za'abeel Ithra - Dubai



Jumeirah Beach Hotel - Dubai



Kempinski Residences - Dubai



Nakheel Island - Dubai



Raffles The Palm Resort - Dubai



Almoosa Specialist Hospital, Ehsaa - KSA



Movenpick Hotel Al Khobar - KSA



Ramada Al Khobar - KSA

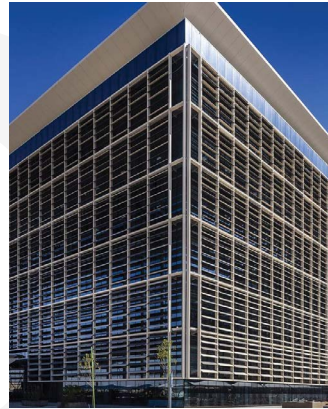

Saudi Electricity Company - KSA



Holiday Inn Al Khobar - KSA



JW Marriott Hotel - Qatar



Ministry of Justice - Riyadh



Ministry of Health - Riyadh

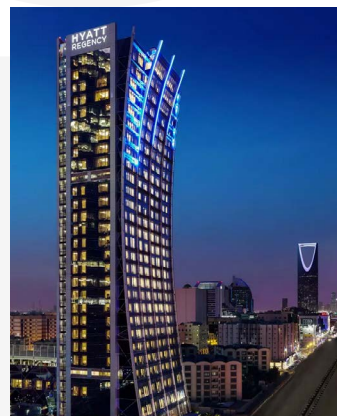

Hyatt Regency - Riyadh



Qatar National Bank



Swiss Hotel Doha - Qatar



Muscat Securities Market - Oman



Nissan Showroom - Oman



Oman Tel - Oman



Salalah Airport - Oman



Ghala Heights Mixed-Use development Muscat-Oman

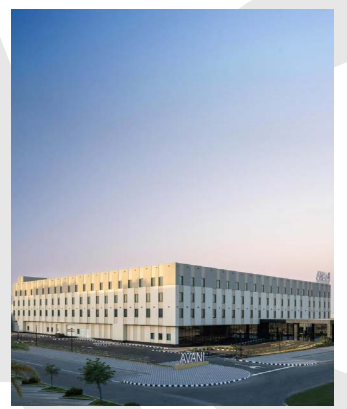

Avani Muscat Hotel & Suites - Muscat Oman



Ministry of Foreign Affairs - Oman



Bahrain Grand Prix



DHL - Bahrain

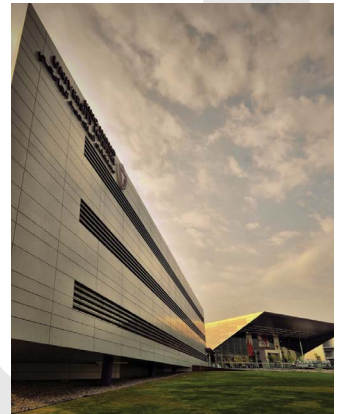

King Hamad Hospital - Bahrain



S Hotel Manama - Bahrain



Nestle Waters - Bahrain

SEDAR BROCHURE

سیدار
SEDAR

— Since 1892 —